

# ROXIE2 - 1166-2 NDW

ULTRA COMPACT - LED 300 W



- **Type:** Followspot
- **Source:** LED 300 W
- **Optics:** 10.5° to 22.5° zoom
- **Colour temperature:** Neutral Daylight White

Followspot

## The little LED wonder with the power punch

Roxie is Robert Juliat's first LED followspot. The compact 300W spot is all about efficiency. It fits in the smallest of spaces and is the ideal energy-efficient solution for all those venues where running costs need to be significantly reduced. Roxie delivers an output comparable to most of the 575W discharge followspot available on the market. No heat, no lamp change, less maintenance. Smooth electronic dimming is available as standard, either locally via the rotary dimmer knob or remotely via DMX.

### Features

- **Fully closing iris:** removable for fast, easy replacement
- **Universal gobo holder:** "A" size glass and metal gobo
- **Local control:** light intensity adjustment through built-in potentiometer
- **Internal glass filter holder:** long term use of durable coloured, dichroic or textured glass
- **Colour changer:** 6-way, 'push/pull' colour changer system for simultaneous use of multiple filters
- **Remote setup:** all parameters can be adjusted by RDM protocol
- **Adjustable response time:** choice of fast or slow dimming for tungsten-like simulation
- **DMX:** 8 or 16 bit dimming and strobe function
- **Local setup:** dMX address and mode, dimming curve and response time through 4-button display with automatic light switch-off
- **Control:** local, DMX, wireless DMX (option)
- **Easy focus reference:** graduated scale on side of the unit; fast and easy refocusing

### Optical

- **SX optical system:** double condenser optics for exceptional optical quality
- **Coated double condenser optical system:** ensures optimal light transmission
- **Variable zoom optics:** sharp focus at every beam angle. Independent control of image size and focus.
- **Electronic dimmer:** dimming without clipping or cut-out at low intensity levels; high quality smoothing
- **No colour shift:** colour temperature remains the same when dimming

### Construction

- **Made in France :** fully manufactured in Robert Juliat premises retaining complete control over all aspects of quality
- **PSU:** built-in electronic flicker-free power supply for easy, plug-and-play installation
- **Power connectors:** neutriK® powerCON TRUE1 TOP IN and OUT connectors for daisy chaining
- **Silent-running cooling fans:** ideal for TV studios and opera houses
- **Electronic thermal management system:** ensures maximum performance of the system without any risk of overheating
- **Bodywork:** strong sheet metal construction for durability
- **Moving parts:** smooth at all times, even when hot
- **Captive knobs and handles:** additional security when working at height or in transit
- **Easy access to all parts:** easy cleaning and maintenance

Picture:1166

DSEN300\_1166-2\_NDW - 02/10/2023

Robert Juliat reserves the right to change or alter any of the items detailed on this page, to increase or improve manufacturing techniques without prior notice.

Robert Juliat S.A.S., 32 rue de Beaumont, 60530 Fresnoy-en-Thelle - France  
Telephone : +33 (0)3 44 26 51 89 - info@robertjuliat.fr - www.robertjuliat.com



ROBERT JULIAT

## Source

- **Lamp type:** LED
- **Power:** 247 W

LED specifications	Power *	Lumen output*	Colour temperature*	Life*	CRI* (min)
SUHD60 V3 NDW (RJ / Osram)	247 W	24 150 lm	5000K	100 000 h	92

(\*) manufacturer's data

## Optics

### Characteristics

- **Type:** Zoom
- **Range:** 10.5° to 22.5° (Field angle)
- **Focal length:** 184 - 374 mm

### Gel filter

- **Shape:** Circle
- **Standard size:** 165 mm (6.5 in)

### Gobo

- **Size:** A
- **Material:** Metal  
Glass



## Photometrics (Photometrics report(s) available at the end of the document)

optics: 10,5°-22,5° / Standard

### • Optics @ 10.5°

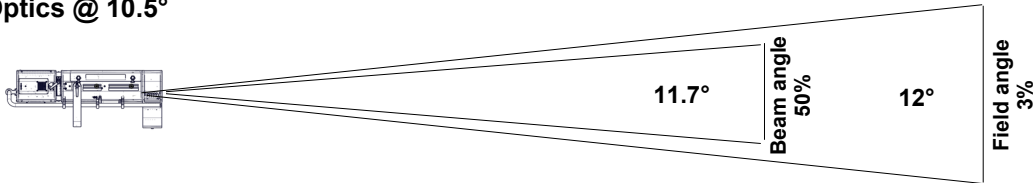

**Beam intensity**  
234 900 cd

**Field lumens**  
6 180 lm

**Efficacy**  
22 lm/W

**CCT**  
5 040 K

**CRI**  
93

<b>Distance</b>	5 m	10 m	15 m	20 m	25 m	30 m
<b>Diameter</b>	1.1 m	2.1 m	3.2 m	4.2 m	5.3 m	6.3 m
<b>Illumination</b>	9 400 lux	2 350 lux	1 050 lux	590 lux	380 lux	270 lux
<b>Distance</b>	15 ft	35 ft	50 ft	65 ft	80 ft	100 ft
<b>Diameter</b>	3.2 ft	7.4 ft	10.5 ft	13.7 ft	16.8 ft	21 ft
<b>Illumination</b>	1 050 fc	200 fc	95 fc	60 fc	37 fc	24 fc

### • Optics @ 22.5°

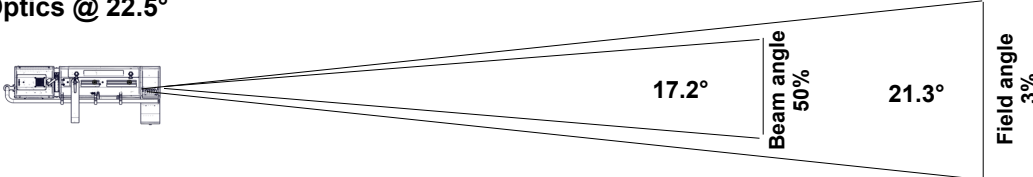

**Beam intensity**  
108 200 cd

**Field lumens**  
7 180 lm

**Efficacy**  
25 lm/W

**CCT**  
5 050 K

<b>Distance</b>	5 m	10 m	15 m	20 m	25 m	30 m
<b>Diameter</b>	1.9 m	3.8 m	5.6 m	7.5 m	9.4 m	11.3 m
<b>Illumination</b>	4 350 lux	1 100 lux	490 lux	280 lux	180 lux	130 lux
<b>Distance</b>	15 ft	35 ft	50 ft	65 ft	80 ft	100 ft
<b>Diameter</b>	5.6 ft	13.2 ft	18.8 ft	24.4 ft	30.1 ft	37.6 ft
<b>Illumination</b>	490 fc	90 fc	44 fc	26 fc	17 fc	11 fc

## Remote control

- **Data protocol:** USITT DMX512-A  
RDM

- **Data IN connector:** 5 pins XLR male
- **Data OUT connector:** 5 pins XLR femelle



### • DMX chart:

#### Mode 1 (1 channels)

Dimmer

#### Mode 2 (4 channels)

Dimmer  
Dimmer fine  
-  
Strobe

#### Mode 3 (5 channels)

Dimmer  
Dimmer fine  
-  
Strobe  
Dimmer master

## Dimensions and weight

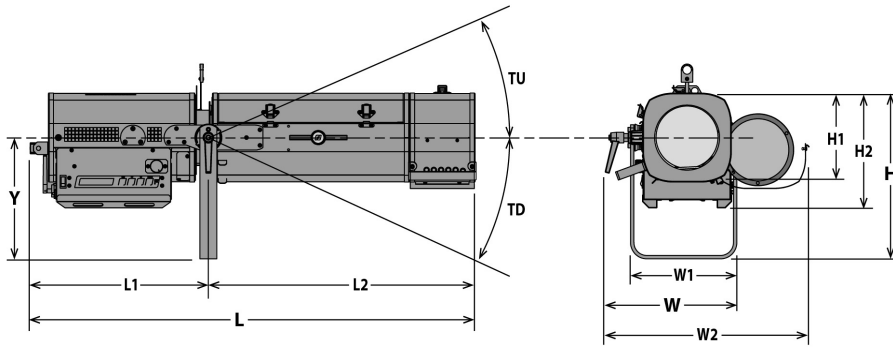

**Weight:** 20.5 kg (45.1 lbs)

Height	Length	Width	Yoke	Tilt
H= 387 mm (15.2 in)	L= 1045 mm (41.1 in)	W= 321 mm (12.6 in)	Y= 283 mm (11.1 in)	TU= 51°
H1= 208 mm (8.2 in)	L1= 418 mm (16.5 in)	W1= 249 mm (9.8 in)		TD= 65°
H2= 268 mm (10.6 in)	L2= 627 mm (24.7 in)	W2= 490 mm (19.3 in)		

## Shipping

- **Weight :** 23.6 kg (51.9 lbs)
- **Volume :** .17 m<sup>3</sup> (6 ft<sup>3</sup>)

## Installation

- **Minimum distance to illuminated surface:** 0.6 m ( 1.8 ft )
- **Operating position:**



## Construction

- **Housing:** Steel sheet - Aluminium
- **Colour:** Black
- **Cooling:** Low noise variable fan
- **Maximum ambient temperature (Ta):** 40°C (104°F)
- **Maximum case temperature (Tc):** 70°C (158°F)
- **Total heat dissipation:** 976 BTU/h
- **Ingress Protection (IP) rating:** IP20

## Electrical compatibility

- 220/230 V - 50 Hz
- 245 V - 50 Hz
- 110/120 V - 60 Hz
- 208 V - 60 Hz
- 220/230 V - 60 Hz
- 100 V - 50 Hz
- 100 V - 60 Hz
- Selector: automatic detection

## Power input



- **Type:** removable power cord with Neutrik powerCON TRUE1 TOP connector (included)
- **Cable:** H07RNF 3G1.5
- **Length:** 3 m (9.8 ft)
- **Power connector:** CEE 7/7 (2P+E NF/Schuko)

## Power consumption

Voltage	Frequency	Current	Power	Power factor
230 V	50 Hz	1.3 A	286 W	0.97
120 V	60 Hz	2.5 A	291 W	0.99
100 V	60 Hz	3 A	295 W	0.99

## Power Supply Unit

- **PSU:** Internal - Electronic PSU - Flicker free with PFC
- **Control:** Local / DMX
- **Protection:** Mains: 4A 1P1D breaker - UL /
- **Power thru:** Neutrik powerCON TRUE1 TOP - Maximum of 10 units (230 V) / 5 units (120 V)

## Warranty

- **Fixture: 3 years - Source: 5 years**  
See General Sales Condition on website

## Approvals





## Acoustics

- **Noise level:** < 24,9 dB(A)













## Model

<b>1166-2 NDW</b>	LED 300 W Followspot - 1166-2 NDW Roxie2 - Neutral Daylight White - 10.5/22.5°
-------------------	--

## Options

<b>PCP1716A</b>	16A blue 2P+E 6h IEC60309 power connector	
<b>W-DMX/Z</b>	W-DMX wireless DMX	
<b>FC1124</b>	Flight-case for Ultra Compact range / GT stand - Dim: 1210x600x560mm - Weight: 35 Kg	

## Accessories

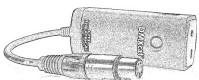
<b>IS750</b>	Full closing iris with holder - Poids: 0.35 Kg <b>1 included</b>	
<b>PF1114</b>	Ø165 mm metal filter holder <b>6 included</b>	
<b>SGUX</b>	Universal "A" size gobo-holder (metal, glass, frosted glass) <b>1 included</b>	
<b>M165TP</b>	6 ways "push/pull" colour changer - Poids: 2.09 Kg <b>1 included</b>	
<b>GT1000</b>	Tripod stand - SWL: 40 Kg - max. height: 1550 mm - Poids: 9.27 Kg	
<b>GT800</b>	Tripod stand - SWL: 40 Kg - max. height: 1550 mm - Poids: 7.98 Kg	
<b>T1000</b>	TV spigot with followspots swivel head - Poids: 1.82 Kg	
<b>T4000</b>	Followspot mount for Ø50mm pipe (suspension or overhead) - SWL= 100 Kg - Poids: 4.88 Kg	
<b>CAV600A</b>	Double slot front cassette for 180x180mm accessories - Poids: 0.43 Kg	
<b>VD120</b>	120x120mm frosted glass	
<b>Kit TELRAD</b>	Telrad followspot sight with raiser and universal mounting kit - Poids: 1.23 Kg	
<b>SDUP</b>	Followspot cue sheet holder with universal mounting kit	
<b>DMXcat</b>	Bluetooth DMX/RDM Multifunction test tool - City Theatrical DMXcat®	

**FC1124/S**

Flight-case for Ultra Compact range / GT stand - Poids: 35 Kg



**W/GT800**

Set of 3 wheels for GT800/1000 stand - Poids: 2.33 Kg



• Optics @ 10,5°

Field lumens	Beam lumens	Efficacy	Beam intensity	CCT	Delta uv
6 180 Lm	6 080 Lm	22 Lm/W	234 900 Cd	5 040 K	

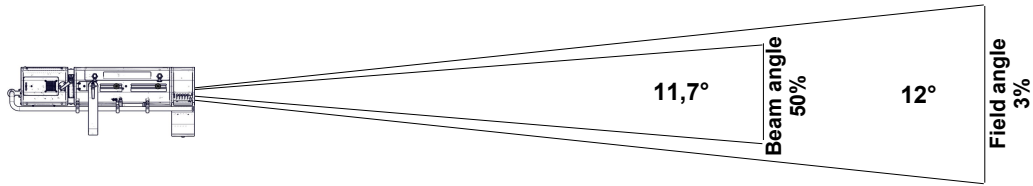

Distance	5 m	10 m	15 m	20 m	25 m	30 m
Field diameter	1,1 m	2,1 m	3,2 m	4,2 m	5,3 m	6,3 m
Illumination	9 400 lux	2 350 lux	1 050 lux	590 lux	380 lux	270 lux
Distance	15 ft	35 ft	50 ft	65 ft	80 ft	100 ft
Field diameter	3,2 ft	7,4 ft	10,5 ft	13,7 ft	16,8 ft	21 ft
Illumination	1 050 fc	200 fc	95 fc	60 fc	37 fc	24 fc

• Optics @ 17°

Field lumens	Beam lumens	Efficacy	Beam intensity	CCT	Delta uv
7 630 Lm	6 090 Lm	27 Lm/W	156 800 Cd	5 120 K	

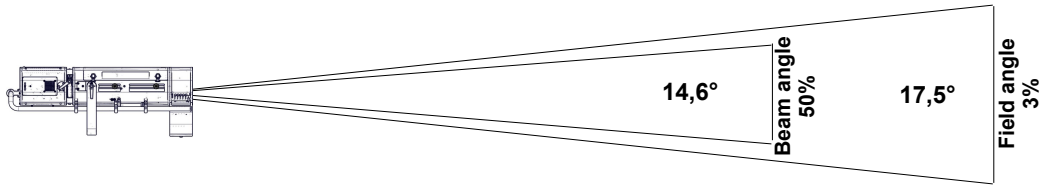

Distance	5 m	10 m	15 m	20 m	25 m	30 m
Field diameter	1,5 m	3,1 m	4,6 m	6,2 m	7,7 m	9,2 m
Illumination	6 300 lux	1 600 lux	700 lux	400 lux	260 lux	180 lux
Distance	15 ft	35 ft	50 ft	65 ft	80 ft	100 ft
Field diameter	4,6 ft	10,8 ft	15,4 ft	20 ft	24,6 ft	30,8 ft
Illumination	700 fc	130 fc	65 fc	38 fc	25 fc	16 fc

• Optics @ 22,5°

Field lumens	Beam lumens	Efficacy	Beam intensity	CCT	Delta uv
7 180 Lm	5 570 Lm	25 Lm/W	108 200 Cd	5 050 K	

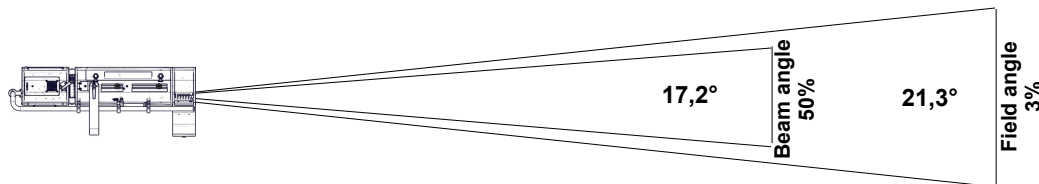

Distance	5 m	10 m	15 m	20 m	25 m	30 m
Field diameter	1,9 m	3,8 m	5,6 m	7,5 m	9,4 m	11,3 m
Illumination	4 350 lux	1 100 lux	490 lux	280 lux	180 lux	130 lux
Distance	15 ft	35 ft	50 ft	65 ft	80 ft	100 ft
Field diameter	5,6 ft	13,2 ft	18,8 ft	24,4 ft	30,1 ft	37,6 ft
Illumination	490 fc	90 fc	44 fc	26 fc	17 fc	11 fc